

OWNER'S MANUAL

HTX-202 2-METER FM TRANSCEIVER

Please read before using this equipment

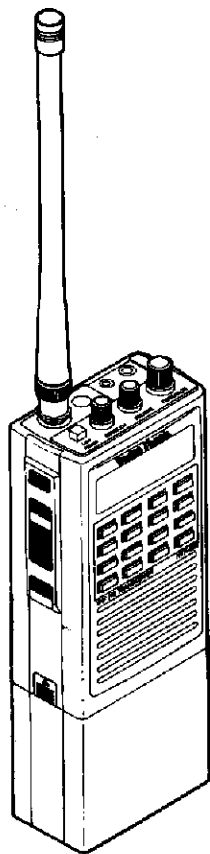

Cat. No. 19-1120

Radio Shack[®]

FEATURES

The Radio Shack HTX-202 Two-Meter Handheld Transceiver offers both the newly licensed Tech and the experienced amateur some of the most advanced features ever presented in a handheld transceiver. Be sure to read this entire manual to learn about all of your transceiver's capabilities.

Note: You must have a Technician Class or higher Amateur Radio Operator's License and a call sign issued by the FCC to legally transmit using this transceiver. Transmitting without a license carries heavy penalties. Getting a license is easier than ever. See "Introduction to Amateur Radio" for more information.

True FM Modulation—provides a more natural-sounding signal, with high clarity and better performance on packet systems.

16 Frequency Memories—include one calling-frequency memory, three priority-frequency memories, and 12 standard memories.

Individually Programmable Repeater Offsets—let you program a different repeater offset frequency for each memory, and a default repeater offset for manually-tuned frequencies.

Subaudible Tone Transmit and Decode (CTCSS)—let you transmit the subaudible tone required by some repeaters, and also let you set a subaudible tone that your transceiver must receive to open the squelch.

Touch-Tone Page—lets you set a sequence of up to five touch tones your transceiver must receive to sound an alert tone and open the squelch.

16-Digit DTMF Output—lets you transmit all touch tones (0-9, #, *, and A-D).

Dual-Power Transmitter—lets you select between 1-Watt and 6-Watt to preserve battery power.

Programmable Power Saver—extends battery life by setting the receiver to standby when squelched.

Five DTMF Memory Sequences—let you store five touch-tone sequences of up to 15 digits each so that you can quickly transmit the sequences you commonly use to activate repeaters or autopatches, or other stations equipped with touch-tone page.

Multi-Function Scanning—lets you scan standard memories, priority-frequency memories, or a frequency range, and automatically resume scanning when the carrier drops, resume scanning after 10 seconds, or stop scanning when a carrier is detected.

Programmable Frequency Step—lets you set the frequency step for tuning or scanning to 5, 10, 15, 20, 25, 50, or 100 kHz.

©1993 Tandy Corporation.
All Rights Reserved.

Radio Shack is a registered trademark used by Tandy Corporation

CONTENTS

Manual Conventions	5
Introduction to Amateur Radio	6
Preparation	8
Power Sources	8
Operating from the Rechargeable Power Pack	8
Using Alkaline Batteries	9
Operating from Vehicle Battery Power	10
Operating from AC Power	10
Backup Battery	12
Connecting the Antenna	12
Attaching the Belt Clip	13
Attaching the Hand Strap	13
Using an External Microphone	14
Using an External Speaker	14
Using the Transceiver with Packet Radio	15
Resetting the Transceiver	15
Using the Light	15
Basic Operation	16
Setting Squelch and Volume	16
Setting a Frequency	16
Tuning Using Direct Entry	16
Tuning Using the Tune Control	17
Scanning for Active Frequencies	17
Scanning for a Vacant Frequency	18
Receiving Transmissions	18
Transmitting	18
Locking the Keypad	19
Setting the Key Entry Beep	19
Reversing the Offset	19
Using Memory Channels	20
Using the Calling-Frequency Memory	20
Using the Priority-Frequency Memories	22
Using the Standard Memories	23
Clearing Memories	24
Moving a Memory Channel to the Manual Mode	24
Reviewing Programmed Options	25

Advanced Operation	26
Understanding the Configuration Menu	26
Setting the Duplex Separation Default	27
Using Subaudible Tone Squelch (CTCSS)	28
Setting the Scan Options	29
Setting the Frequency Step Rate	29
Setting the Scan Resume Condition	29
Setting the Scan Delay Duration	30
Setting the Scan Limits	30
Setting the Vacant Scan Direction	30
Using the Power-Save Feature	31
Preventing Transmissions	31
Limiting Transmission Duration	32
Setting the Priority Scan Time	32
Using Touch-Tone Features	33
Manually Sending Touch Tones	33
Storing a DTMF Memory Sequence	33
Transmitting a DTMF Memory Sequence	34
Using DTMF Squelch for Paging	34
Automatically Sending a DTMF Reply	34
Care and Maintenance	35
Error Codes	36
Specifications	37
Schematic (Digital).....	39
Schematic (RF).....	40
Key Index	41

MANUAL CONVENTIONS

Your transceiver's buttons each have two or more functions. The abbreviation for the function is printed on the button, above the button, to the left of the button, or below the button. For functions below or to the left of the button, the function is printed in orange. To make this manual clearer, buttons are referred to by the function being used. For example, the lower right button on the keypad is referred to in different sections as **D**, **CLR**, **VF**, and **M→VFO**.

To activate certain transceiver features you must press **F**(function) plus another button. Such key combinations are printed with a **+** between the button names. For example, **F+BEEP** means press and hold down **F** while you press **BEEP**.

Also, this manual uses the following text conventions:

Button names are printed in small, bold, capital letters: **BEEP**, **DTMF**, and so on.

Words, symbols, and numbers that appear on the display are printed in a distinctive typeface: **146.940**, **M-CH**, and so on.

INTRODUCTION TO AMATEUR RADIO

We designed your HTX-202 handheld transceiver to be the perfect first radio for anyone entering the exciting world of amateur radio and a great additional transceiver for experienced amateur radio operators. From almost anywhere you will find that your transceiver opens a door to the world! All you need is an Amateur Radio Operator's License, Technician Class or higher, issued by the Federal Communications Commission (FCC). If you do not have a license, you will find that it is easy to get one, and that there is much help available. Here are a few tips to help you get started.

First, go ahead and turn on your transceiver and use the receiver to tune around on the band to hear what is going on. **Do not even think of transmitting until you get your license.** That is very important. Transmitting without a license is a violation of federal law that can lead to severe penalties. Also, ham operators take the FCC rules very seriously and want nothing to do with **bootleggers** — their term for people who operate without a license.

Second, find out if there is a ham radio club in your area. There are thousands of clubs across the country, so there is probably at least one in or near your own community. The people at the Radio Shack store where you bought your transceiver might be able to tell you. If not, and if you do not hear anyone talking about a local club in your area as you tune around the band with your transceiver, write to the American Radio Relay League (ARRL) for information on how to contact their local affiliate. Most clubs welcome newcomers and are glad to help you get your license.

Next, start studying for your license. Do not let the word **study** scare you, because most people can go from knowing absolutely nothing about amateur radio to passing the Novice and Technician written exams in less than a month. The exams test your knowledge of basic radio regulations and elementary radio theory. While Morse code is no longer required for a Technician Class license, we encourage you to learn Morse now, so that you can advance to additional operating privileges. Many clubs teach license classes (a fun and easy way to learn about amateur radio), and there are good books, cassette tapes, computer programs, and many other study aids available. Radio Shack stores sell FCC License Preparation study guides for Novice, Technician, and General Class licenses.

When you are ready to take the test, you do not have to go to an imposing Federal office building in a big city to take the test, because these days the FCC has authorized ham volunteers to give all the exams. The examiners for a Novice license test can be any two ham operators with general or higher class licenses that are at least 18 years old and are not related to you. And, the Novice exam is free. If you pass the Novice exam, you can immediately take the Technician exam. You must pay a small fee to take the Technician exam, and the test must be administered by a three-member Volunteer Examiner Team. You can get a schedule of exam opportunities in your area from the ARRL.

The Technician Class license lets you use the entire range of your HTX-202 to communicate directly with other operators, communicate through repeaters, or connect to a terminal-node controller and use packet to directly send and receive information with a computer.

We have mentioned the ARRL several times. That is because the League is the national organization that represents amateur radio in the United States. The League has more than 150,000 members; most of them are ham operators, but many are ham operators-to-be. Here is the address of ARRL headquarters.

The American Radio Relay League
225 Main Street
Newington, CT 06111

The ARRL staff helped us prepare this section of the owner's manual, and they would be glad to hear from you if you need more information, or if you would like to join!

Amateur radio is a great hobby that has enriched the lives of millions of people all over the world. We take pride in bringing to you the HTX-202 to enrich your life.

PREPARATION

POWER SOURCES

You can operate your transceiver from any of the following power sources:

- Rechargeable power pack (supplied with charger)
- Six alkaline AA batteries (using the supplied alkaline pack)
- Vehicle battery power (using an optional adapter)
- AC power (using an optional adapter)

Operating from the Rechargeable Power Pack

You can use the supplied rechargeable power pack to power your transceiver. This power pack provides 7.2 volts, and can operate your transceiver at 2.5 watts (typical power) with the **LOW POWER** button out. As supplied, the power pack is fully discharged. You need to fully charge the pack using the supplied charger before you operate the transceiver from the rechargeable pack. Follow these steps to charge the pack.

1. If the pack is attached to the transceiver, turn off the transceiver. Do not operate the transceiver while you charge the power pack.

Note: You can remove the power pack from the transceiver to charge it, and operate the transceiver from one of the other power sources.

2. Plug the supplied charger's barrel plug into the **CHARGE** jack on the back of the power pack.
3. Plug the charger into a standard AC outlet. The **CHARGE** indicator lights.

It takes about 10 hours to charge the power pack.

When power is low, **BATT** appears on the display when you press **PTT**.

You can buy extra power packs through your local Radio Shack store.

Note: Nickel-cadmium batteries deliver more power if you occasionally let them completely discharge. To do this, use the transceiver until **BATT** appears on the display when you press PTT. Then, fully charge the batteries. If you do not occasionally do this, the batteries can temporarily lose the ability to deliver full power. Also, to ensure a full charge, be sure the batteries are at room temperature (above 65°F) when you charge them. Cold batteries do not fully charge.

Cautions:

- To prevent permanent nickel-cadmium power loss, never charge the power pack in an area where the temperature is above about 80°F.
- Never use a charger other than the one supplied to charge the power pack. Even chargers with the same voltage and current ratings could permanently damage the transceiver or the power pack. You can order a replacement charger at your local Radio Shack store.

Using Alkaline Batteries

You can operate the transceiver from six AA batteries (not supplied) using the supplied alkaline battery holder. This battery holder supplies 9 volts and can operate your transceiver at 4 watts (typical power) with the **LOW POWER** button out. Follow these steps to load or replace batteries in the alkaline battery holder.

1. Hold the outer battery holder case and push down on the center of the battery holder, as shown.

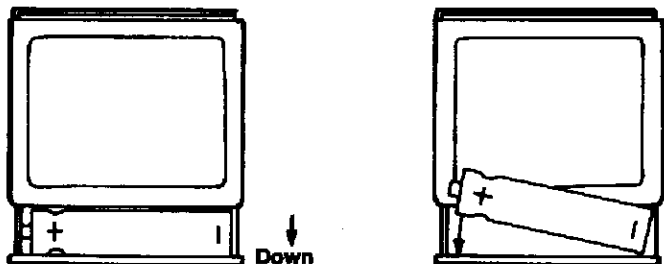

2. Remove old batteries, if necessary, and install six fresh AA alkaline batteries, observing correct polarity as indicated by the markings (+ and -) in the battery holder.

-
-
3. Press the battery holder into the battery holder case.

When power is low, **BATT** appears when you press PTT. Be sure to use six fresh AA alkaline batteries. Never mix different types of batteries, and never mix old and new batteries.

Operating from Vehicle Battery Power

You can operate the transceiver from vehicle battery power using a DC power cord (Radio Shack Cat. No. 270-1533). This cord supplies 13.8 volts (typical) to your transceiver and can operate your transceiver at 6 watts (typical power) with the **LOW POWER** button out. Follow these steps to operate from vehicle battery power.

1. Plug the power cord's barrel plug into the transceiver's **EXT DC** jack.

Caution: Never plug the power cord into the rechargeable power pack's **CHARGE** jack. Doing so can damage the power pack and the transceiver.

2. Plug the power cord's cigarette-lighter plug into your vehicle's cigarette-lighter socket.

If the transceiver does not operate, remove the power cord's plug from the cigarette-lighter socket and check the socket for debris. Clean the socket, if necessary, and try again.

Operating from AC Power

You can operate the transceiver from AC power using either the 1-amp 12-volt DC adapter (Cat. No. 273-1653) or our regulated 2.5-amp power supply (Cat. No. 22-120). The 2.5-amp power supply lets you operate your transceiver at 5 watts (typical power) with the **LOW POWER** button out and is better isolated from 60Hz noise. The 1-amp adapter connects very quickly and requires no soldering, but only operates your transceiver at about 2 watts with the **LOW POWER** button out.

Follow these steps to power the transceiver from the 1-amp, 12 volt DC adapter.

1. Connect the barrel plug with the tip set to positive.
2. Insert the adapter's barrel plug into the transceiver's **EXT DC** jack.

Caution: Never insert the adaptor's barrel plug into the rechargeable power pack's CHARGE jack. Doing so can damage the power pack and the transceiver.

3. Plug the adapter into an AC outlet.

Follow these steps to power the transceiver from the regulated 2.5-amp power supply.

Note: You need the following materials to use the regulated 2.5-amp power supply:

- Power supply (Cat. No. 22-120)
 - Two-conductor 18-gauge wire (Cat. No. 278-567)
 - DC power connector (Cat. No. 274-1567)
 - Soldering iron and solder
 - Voltmeter or multimeter
1. Cut the 2-conductor wire to the length power cord you need.
 2. Strip about 1/2-inch of insulation from each end of both conductors.
 3. Solder one end of the wire to the DC power connector, with the red lead connected to the center terminal, and the black lead connected to the outer casing.
 4. Melt a small amount of solder onto the other end of the wire. Then, connect the red lead to the power supply's + terminal and connect the black lead to the power supply's - terminal.
 5. Plug in the power supply and turn it on. Use the meter to confirm that you have correctly wired the power connector so that the tip is positive and the outer case is negative.
 6. Turn off the power supply and plug the power connector into the transceiver EXT DC jack.
- Caution:** Never plug the power connector into the rechargeable power pack's CHARGE jack. Doing so can damage the power pack and the transceiver.
7. Turn on the power supply.

Backup Battery

Your transceiver uses a lithium battery to keep stored options in memory when you disconnect the transceiver from a power source. This battery should last 3 to 5 years, under normal conditions. When the transceiver frequently displays ER1, the backup battery needs to be replaced.

Note: To clear the error, reset the transceiver. See "Resetting the Transceiver."

The backup battery is not user-serviceable. Take the transceiver to your local Radio Shack store to have the battery replaced by a Radio Shack repair center.

This product contains a rechargeable nickel cadmium (Lead acid) battery. At the end of the battery's useful life, it must be recycled or disposed of properly. Contact your local, county, or state hazardous waste management authorities for information on recycling or disposal programs in your area. Some options that might be available are: Municipal curb-side collection, drop-off boxes at retailers, recycling collection centers, and mail-back programs.

CONNECTING THE ANTENNA

Your transceiver comes with a flexible antenna. You must connect an antenna to your transceiver before you transmit. The transceiver's BNC antenna connector makes it easy to connect other types of antennas. Radio Shack stores sell a 5/8-wave magnetic mount antenna for mobile operation (Cat. No. 19-210), a discone antenna (Cat. No. 20-013), and a center-loaded telescoping whip antenna (Cat. No. 20-006) that you can also use with your transceiver.

To use the supplied antenna, slip the antenna's connector over the BNC jack and twist the antenna to lock it in place.

To use an external antenna, if necessary, attach the appropriate connector adapter to the end of the antenna cable. Then, slip the connector over the BNC jack and twist the connector to lock it in place.

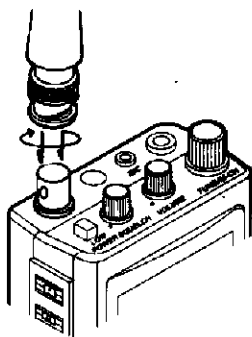

Warning: When installing or removing an outdoor antenna, use extreme caution. If the antenna starts to fall, let it go! It could contact overhead power lines. If the antenna touches the power line, contact with the antenna, mast, cable, or guy wires can cause electrocution and death! Call the power company to remove the antenna. Do not attempt to do so yourself.

ATTACHING THE BELT CLIP

You can attach the provided belt clip to your transceiver. Use the supplied screws as shown.

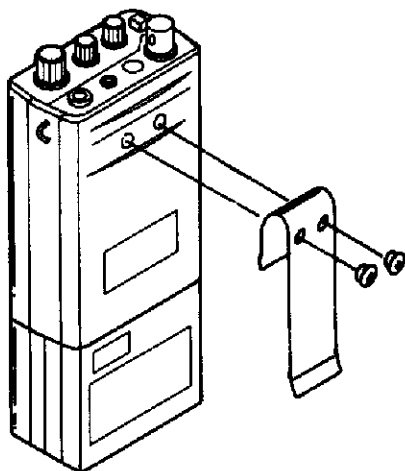

ATTACHING THE HAND STRAP

Loop the supplied hand strap's key ring through the hand strap tab, as shown.

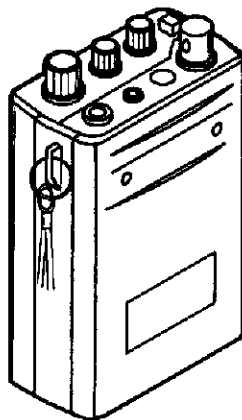

USING AN EXTERNAL MICROPHONE

You can use an external microphone with your transceiver. When you connect an external microphone, the internal microphone does not work, but the internal PTT is not affected. If your microphone has a 3/32-inch (2.5 mm) submini plug, plug the microphone cable into the transceiver's MIC jack.

See the following two diagrams for specific microphone connections.

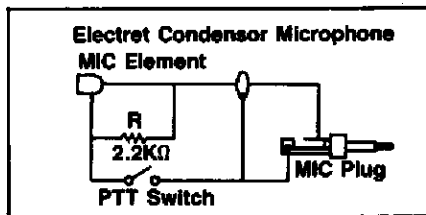
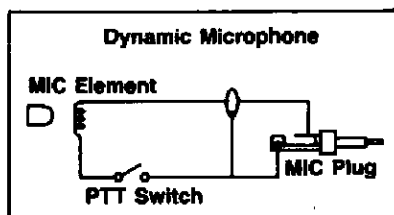

USING AN EXTERNAL SPEAKER

In a noisy area, an external speaker, positioned in the right place, might provide more comfortable listening. Radio Shack stores sell an extension speaker (Cat. No. 21-549) and an amplified communications extension speaker (21-541). Plug the speaker cable's 1/8-inch (3.5mm) mini plug into the transceiver's SP jack. This disconnects the internal speaker.

For the most efficient operation when you carry the transceiver on your belt, connect a combination speaker/microphone (such as Cat. No. 19-310) to your transceiver and hang the mic/speaker on your collar.

If your vehicle has a cassette player, you can easily connect your transceiver to your vehicle's audio system using a CD-to-cassette adapter (Cat. No. 12-1951) and a mono-to-stereo audio plug (Cat. No. 274-368). Simply insert the adapter in your vehicle's cassette player, connect the adapter's plug to the mono-to-stereo plug, insert the plug in the transceiver's SP jack, and turn on your cassette player.

USING THE TRANSCEIVER WITH PACKET RADIO

You can connect your transceiver directly to a packet radio terminal node controller. See the following diagram for a suggested connection.

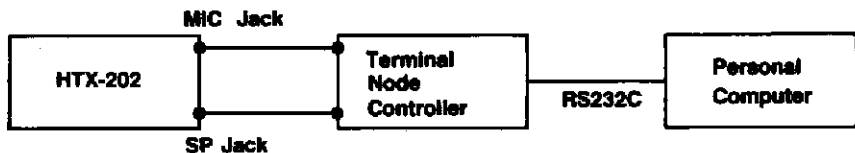

RESETTING THE TRANSCEIVER

When you first use the transceiver, if the transceiver displays ER1, or if you ever want to reset the transceiver's options to the factory defaults and clear all memories, follow these steps.

Warning: This procedure clears all stored information from the transceiver.

1. Turn off the transceiver.
2. Press and hold down F + CLR. Then, turn on the transceiver.

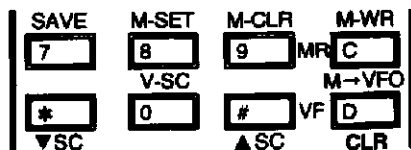

USING THE LIGHT

Press L on the side of the transceiver to turn to the display light for about 5 seconds. To turn off the light sooner, press L again. If you want the light to stay turned on, press F + L at the same time. The light stays on until you press L or turn off the transceiver.

BASIC OPERATION

SETTING SQUELCH AND VOLUME

Rotate **VOLUME** clockwise and **SQUELCH** counterclockwise until you hear a hissing sound. Then, slowly rotate **SQUELCH** clockwise until the noise stops. Leave **VOLUME** set to a comfortable level.

If the transceiver picks up unwanted weak transmissions, rotate **SQUELCH** clockwise to decrease the transceiver's sensitivity to signals.

SELECTING A FREQUENCY

You can use any of three methods to select a frequency to communicate on.

- Direct entry
- Tune control
- Scanning for frequencies

Tuning Using Direct Entry

Your transceiver transmits and receives on frequencies between 144.000 and 148.000 MHz. To quickly tune to a frequency, enter the frequency using the keypad.

1. Turn on the transceiver.
2. Press VF.
3. Use the keypad to enter the last four digits of the frequency. For example, to enter 146.940, press 6940.

T-SQL	DTMF	+/-	LOCK
1	2	3 CA	A
D-SQL	BEEP	REV	P-SC
4	5	6 PR	B
SAVE	M-SET	M-CLR	M-WR
7	8	9 MR	C
*	V-SC	#	M→VFO
▼SC	0	▲SC	VF D
			CLR

Notes:

- If you make a mistake, press CLR and repeat this step.
- The transceiver rounds the last digit down to 0 or 5.

Tuning Using the Tune Control

You can quickly tune to a nearby frequency by rotating **TUNE** on top of the transceiver.

1. Turn on the transceiver.
2. Press **VF**.
3. Rotate **TUNE** counterclockwise to tune down or clockwise to **TUNE** up. The transceiver tunes up or down one frequency step per click. To change the frequency step, see "Setting the Frequency Step Rate."

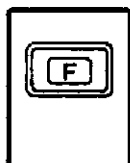

T-SQL	DTMF	+/-	LOCK
1	2	3 CA	A
D-SQL	BEEP	REV	P-SC
4	5	6 PR	B
SAVE	M-SET	M-CLR	M-WR
7	8	9 MR	C
	V-SC		M-VFO
*	0	# VF	D
▽SC		▲SC	CLR

Scanning for Active Frequencies

You can search for activity on a frequency by pressing and holding down **▲SC** or **▽SC** for at least 1 second. The transceiver begins to scan up or down the full frequency range, and stops on active frequencies. To scan only a selected frequency range press **F + ▲SC** or **F + ▽SC**. See "Setting the Scan Options" to see how to change the scanning range, the frequency step, the scan resume condition, and the scan delay time. The following are the factory presets for these options.

Frequency Step : 15KHz

Scan Resume Condition : Resumes scanning in 10 seconds, regardless of absence or presence of carrier.

Scan Delay : Not activated.

Scan Limits : 144 MHz to 148 MHz

To stop scanning, press **▽SC**, **▲SC**, **CA**, **PR**, **MR**, **VF**, or turn off the transceiver.

Scanning for a Vacant Frequency

In some areas where the 2-meter band is being used heavily, you might have trouble quickly finding a frequency not being used. To quickly scan for a vacant frequency, press **F + V - SC**. The transceiver scans up or down from the current-frequency to the first unused frequency. To change the vacant scan direction, see "Setting the Vacant Scan Direction."

RECEIVING TRANSMISSIONS

To receive transmissions, turn on the transceiver, adjust the volume and squelch, and tune to a frequency.

TRANSMITTING

There are two basic types of communication you can use with this transceiver. These types are sometimes referred to as **simplex** and **duplex**. With simplex transmissions, you transmit and receive on the same frequency. With duplex transmission, you transmit on one frequency and receive on another. Duplex transmission is the communications type you use when you communicate using a repeater. You transmit to the repeater on one frequency (the input frequency), and the repeater retransmits the signal at a different frequency (the output frequency).

Caution: Do not transmit if you do not have a Technician Class or higher license issued by the FCC. Doing so is illegal.

Follow these steps to communicate using simplex communications.

1. Turn on the transceiver.
2. Select the desired frequency.
3. If **+** or **-** is on the display, repeatedly press **F + +/-** until neither symbol appears.
4. Press **LOW POWER** so that the button is down. In this position, your transceiver transmits at about 1 watt.
5. Begin communications.

If the other party advises that you need to improve your signal (QRO), press **LOW POWER** so that the button is up. In this position, your transceiver transmits at the highest power it can, depending on the power source. See "Power Sources" or "Specifications" for these power levels. Remember to switch back to low power whenever possible, to comply with the FCC rules that require you to use the minimum power necessary to maintain communications.

Follow these steps to communicate using duplex communications.

1. Turn on the transceiver.
2. Tune to the desired receive (output) frequency.
3. If the transmit (input) frequency is 600 kHz **above** the receive frequency, press **F+ +/-** so that **+** appears in the display. If the transmit frequency is 600 kHz **below** the receive frequency, press **F+ +/-** so that **-** appears on the display. If the frequency separation is not 600 kHz, either set a new default frequency separation or store the frequency pair in one of the scanner's memories (See "Using Memory Channels" and "Setting the Duplex Separation").

LOCKING THE KEYPAD

To lock the transceiver's keypad so that you do not accidentally change a setting, press **F+ LOCK**. **LOCK** appears on the display. This locks all front-panel buttons and the tune control. The **PTT**, **VOLUME**, and **SQUELCH** still operate. To release the lock, press **F+ LOCK** again.

SETTING THE KEY ENTRY BEEP

Each time you press a key, the transceiver sounds a beep. To turn off the beep, press **F+ BEEP**. The key beep does not sound for this or subsequent key presses. To turn on the key beep, press **F+ BEEP** again.

REVERSING THE OFFSET

To reverse the transmit and receive frequencies when you are operating duplex, press **F+ REV**. For example, if you are set to 146.94 with a **-** offset pressing **F+ REV** makes the transceiver receive on 146.14 and transmit on 146.94.

USING MEMORY CHANNELS

Your transceiver has 16 memory channels in three groups.

- One calling-frequency memory
- Three priority-frequency memories
- 12 standard memories

Using the Calling-Frequency Memory

The calling-frequency memory provides a single memory that you can quickly jump to at any time. Follow these steps to save a frequency in the calling-frequency memory.

1. Press **VF**.
2. Tune to the frequency you want to save.
3. Press **CA**.
4. If the frequency is for a repeater that requires subaudible tone access or if you want to use incoming subaudible tone squelch with frequency, press **F + T-SQL** so that **T-SQL** appears on the display.

Note: If you turn on **T-SQL** you must correctly set both the transmit subaudible tone and the receive subaudible tone as described in steps 8 through 11.

5. Press and hold down **F + M – WR** for at least 1 second.

The transceiver stores the tuned frequency in the calling-frequency memory, plus the frequency separation (for duplex operation) and subaudible transmit and receive tones. For more information about subaudible tones, see “Using Subaudible Tone Squelch (CTCSS).”

-
6. If you want to set a different transmit frequency or change the subaudible tones, press **F + M-SET**. The transceiver displays **TF** followed by the transmit frequency.
 7. Rotate **TUNE** to change the transmit frequency.
 8. To set a transmit subaudible tone frequency, press **▼SC**. The transceiver displays **TC** followed by the transmit subaudible tone frequency.
 9. Rotate **TUNE** to set the transmit subaudible tone frequency.
Note: If you do not want to transmit a subaudible tone, rotate **TUNE** to set the transmit subaudible tone to **OFF**.
 10. To set a receive subaudible tone frequency, press **▼SC**. The transceiver displays **RC** followed by the receive subaudible tone frequency.
 11. Rotate **TUNE** to set the receive subaudible tone frequency.
Note: If you do not want to use incoming tone squelch, rotate **TUNE** to set the receive subaudible tone to **OFF**. Otherwise, you do not hear transmissions unless the subaudible tone is present.
 12. Press **PTT** to save the settings and return to the calling-frequency memory display.
To use the calling frequency memory, press **CA** at any time. The transceiver immediately goes to the calling frequency and sets the transmit frequency, subaudible tones, and tone squelch to the settings you programmed. To return to the previous settings, press **CA** again.

Using the Priority-Frequency Memories

The transceiver has three priority-frequency memories. The transceiver can periodically scan these frequencies during manual, calling-frequency memory, or standard memory operation. Follow these steps to store a frequency in the priority-frequency memories.

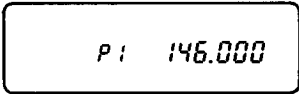
1. Press **VF** and tune to the frequency you want to save.
2. Press **F** and rotate **TUNE** until either **P1**, **P2**, or **P3** appears to the left of the tuned frequency.

3. If the frequency is for a repeater that requires subaudible tone access or if you want to use incoming subaudible tone squelch with this frequency, press **F + T-SQL** so that **T-SQL** appears on the display.
4. Press **F + M - WR** for at least 1 second to store the tuned frequency in the selected priority-frequency memory.
5. To change the frequency separation or subaudible tones, press **PR** and rotate **TUNE** to select the priority-frequency memory you want to change. Then, refer to steps 6 through 12 under "Using the Calling-Frequency Memory." Each priority frequency memory can have different settings.

To set the transceiver to a priority frequency, press **PR**. Then rotate **TUNE**, press **▲SC**, **▼SC**, 1, 2, or 3 to select one of the three memories.

To have the scanner check the priority-frequency memories for activity, press **VF**. Then, press **F+P-SC** for at least 1 second. The transceiver checks the priority-frequency memories every 4 seconds. To change the priority scan time, see "Setting the Priority Scan Time."

To continuously scan the three priority frequency memories, press **PR**. Then, press and hold down **▲SC** or **▼SC** at least 1 second.

Note : You must store more than one priority frequency in memory to continuously scan priority-frequency memories.

Using the Standard Memories

Your transceiver has 12 standard memories into which you can store frequently-accessed frequencies for quick access. Follow these steps to store frequencies in standard memories.

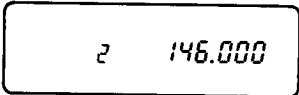
1. Press **VF** and tune to a frequency you want to store.
2. Press **F** and rotate **TUNE** until the memory number to the left of the frequency display shows the standard memory you want to store into. 
3. Press **F + M - WR** for at least 1 second to store the tuned frequency into the selected standard memory.
4. To change the frequency separation or subaudible tones, press **MR** and rotate **TUNE** to select the standard memory you want to change. Then, refer to steps 6 through 12 under "Using the Calling-Frequency Memory." Each standard memory can have different settings.

To set the transceiver to a standard memory, press **MR**. Then, rotate **TUNE** or press **▲SC** or **▼SC** to select one of the 12 memories.

To continuously scan standard memories, press **MR**. Then, press and hold down **▲SC** or **▼SC** for at least 1 second.

Note: The transceiver stops scanning according to the scan options you have set. See "Setting the Scan Options" for more information.

Clearing Memories

Follow these steps to clear a memory.

- 1 Press **PR** or **MR** and select the memory you want to clear.
2. Press **F + M - CLR** to clear the settings stored in the current memory.

Note: You cannot clear Standard Memory 1 or the calling-frequency memory. You can only change the memory settings for these memories.

Moving a Memory Channel to the Manual Mode

Follow these steps to quickly move a memory channel to the manual (**VF**) mode.

1. Select the memory channel.

2. Press **F + M → VFO**.

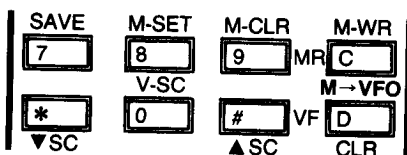

All settings for the selected memory move to the **VF** mode.

REVIEWING PROGRAMMED OPTIONS

Follow these steps to view the transmit frequency and the subaudible transmit and receive tone settings for a memory or the tuned VF frequency.

1. Press **CA**, **PR**, **MR**, or **VF** and select the memory or frequency you want to check.
2. If you want to check the subaudible tone settings, press **F + T - SQL** so that **T-SQL** appears on the display.

T-SQL 1	DTMF 2	+/- 3	CA	LOCK A
D-SQL 4	BEEP 5	REV 6	PR	P-SC B



3. Press **M** (located above **PTT**). The transceiver's squelch opens, and the display shows the transmit frequency for about 1 second, followed by the subaudible transmit tone and the subaudible receive tone.

ADVANCED OPERATION

UNDERSTANDING THE CONFIGURATION MENU

Your transceiver has a configuration menu that lets you modify operation settings. Each of the following sections explains how and when to use each configuration setting. Follow these steps to turn on the configuration menu and select options.

1. Press **VF**.
2. Press **F + M – SET**. The first menu item appears.
3. Press **▼SC** or **▲SC** to step down or up through the menu items. Rotate **TUNE** to change the setting for any menu item.
4. Press **PTT** to exit the configuration menu and save all settings.

The configuration menu appears in the following order:

Code	Factory Default	Explanation
oS	0.600	Duplex separation (offset)
tc	oFF	Transmit subaudible tone
rc	oFF	Receive subaudible tone
Sr	15	Frequency step
Sc	ti	Scan resume
Sd	2.0	Scan delay time
S1	144.000	Lower scan range limit
S2	148.000	Upper scan range limit
ud	dn	Vacant channel scan direction
PS	1-16	Power save duty cycle
tE	oFF	Transmit inhibit
to	oFF	Transmit time-out
Lb	4	Priority-frequencychannel lookback time
Ar	oFF	Touch-tone auto-reply

See the following sections for complete information regarding these functions.

SETTING THE DUPLEX SEPARATION DEFAULT

The duplex separation default (offset) controls the offset between the transmit frequency and the receive frequency when you use the transceiver in duplex mode, as with a repeater. Typically, on the 2-meter band, repeaters receive at a frequency 600 kHz lower or higher than they retransmit (repeat) on. For example, if a repeater's input frequency is 146.340 MHz, its output frequency is 146.940 MHz. The following is a list of the most commonly used repeater pairs.

Input Frequency	Output Frequency
146.07 MHz	146.67 MHz
146.13 MHz	146.73 MHz
146.16 MHz	146.76 MHz
146.22 MHz	146.82 MHz
146.25 MHz	146.85 MHz
146.28 MHz	146.88 MHz
146.31 MHz	146.91 MHz
146.34 MHz	146.94 MHz
146.37 MHz	146.97 MHz
146.40 MHz	147.00 MHz

To operate with a repeater, you must transmit on the repeater's input frequency and receive on the repeater's output frequency. If you frequently use a repeater that does not have a 600 kHz offset, we recommend you program the repeater frequency into one of the transceiver's memories. You can override the default offset for each memory.

To change the default offset, follow the steps in "Understanding the Configuration Menu" to display the **oS** menu item, and rotate **TUNE** to change the offset. The transceiver lets you set the offset to be in the range from 0 MHz to 4 MHz in steps as set by the frequency step option.

USING SUBAUDIBLE TONE SQUELCH (CTCSS)

Some repeaters require that you transmit a subaudible tone to key-up the repeater. You can set your transceiver to transmit any of the 38 standard subaudible tones. You can also limit incoming calls by setting your transceiver to open the squelch only when someone transmits a subaudible tone you set.

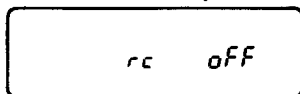
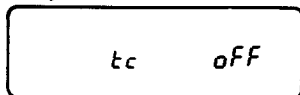

To set a subaudible transmit tone, follow the steps in "Understanding Configuration Menu" to display **tc**. Then, rotate **TUNE** to select the subaudible tone. If you do not want to transmit a subaudible tone, rotate **TUNE** to select **OFF**.

To set a subaudible receive tone, follow the steps in "Understanding the Configuration Menu" to display **rc**. Then, rotate **TUNE** to select the subaudible tone. If you do not want to use the receive subaudible tone squelch, but are using transmit subaudible tone to activate a repeater, rotate **TUNE** to select **OFF**. Otherwise, you only hear transmissions that have the correct subaudible tone when you activate tone squelch.

To turn on the subaudible tone feature, press **F + T - SQL**. When you transmit, the transceiver includes the subaudible tone in the signal. To receive, the incoming signal must have the correct subaudible tone. You can override the default subaudible tones for any memory.

Code	Freq.(Hz)	Code	Freq.(Hz)	Code	Freq.(Hz)	Code	Freq.(Hz)	Code	Freq.(Hz)
XZ	67.0	ZZ	91.5	3Z	123.0	5B	162.2	M3	218.1
XA	71.9	ZA	94.8	3A	127.3	6Z	167.9	M4	225.7
WA	74.4	1Z	100.0	3B	131.8	6A	173.8	M5	233.6
XB	77.0	1A	103.5	4Z	136.5	6B	179.9	M6	241.8
WB	79.7	1B	107.2	4A	141.3	7Z	186.2	M7	250.3
YZ	82.5	2E	110.9	4B	146.2	7A	192.8		
YA	85.4	2A	114.8	5Z	151.4	M1	203.5		
YB	88.5	2B	118.8	5A	156.7	M2	210.7		

SETTING THE SCAN OPTIONS

Several configuration menu items control how your transceiver operates when you scan frequencies or memories. The following sections describe how to set the frequency step rate, the scan resume condition, the scan delay duration, and the scan limits.

Setting the Frequency Step Rate

The frequency step rate affects the scanning mode, the **TUNE** control, and **▲SC** or **▼SC** tuning. The factory default for the frequency step is 15kHz. Each time you rotate **TUNE** one click or press or **▼SC** or **▲SC** the frequency changes by 15 kHz. When scanning, the transceiver scans up or down 15 kHz per step. To change the frequency step rate, follow the steps in "Understanding the Configuration Menu" to display the **Sr** menu item, and rotate **TUNE** to change the frequency step rate. You can set the step rate to 5, 10, 15, 20, 25, 50, or 100 kHz.

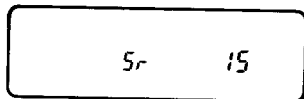

Setting the Scan Resume Condition

When you have set the transceiver to scan either standard memories or VF mode, the transceiver stops whenever it encounters a signal strong enough to break squelch. At the factory setting, the transceiver resumes scanning in 10 seconds, regardless of the presence of a continued signal. You can set the scan resume configuration item to one of the following.

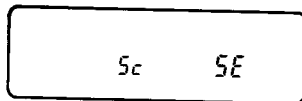
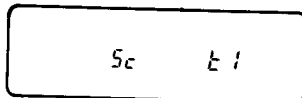
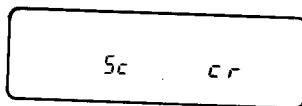

-
-
- ti** Resumes scanning in 10 seconds
 - cr** Resumes scanning after the carrier drops and the scan delay expires
(See "Setting the Scan Delay.")
 - SE** Does not resume scanning

To change the scan resume condition, follow the steps in "Understanding the Configuration Menu" to display **Sc**. Then, rotate **TUNE** to select the scan resume condition.

Note: The scan resume option does not affect priority scan. Priority scan always resumes scanning after the carrier drops.

Setting the Scan Delay Duration

When you set the scan resume condition to **cr** (carrier), the transceiver resumes scanning after the carrier drops. The scan delay option lets you set the transceiver to pause before resuming, so you can hear any reply. The factory default for this option is 2 seconds.

To change the scan delay duration, follow the steps in "Understanding the Configuration Menu" to display **Sd**. Then, rotate **TUNE** to select the scan delay duration. You can set the delay to 0.5, 1, 2, or 4 seconds.

Note: The scan delay option also affects priority scan.

Setting the Scan Limits

When you press **F + ▼SC** or **F + ▲SC** the transceiver scans only those frequencies within a range you set with the scan limit options. To set the scan limits, follow the steps in "Understanding the Configuration Menu" to display **S1**. Use either **TUNE** or the key pad to enter one of the frequency limits. Then, press **▼SC** to display **S2** and enter the other frequency limit. You can enter the higher frequency as either limit.

Setting the Vacant Scan Direction

The transceiver's factory default for vacant scan is to scan down until it finds an unused frequency. To change the vacant scan direction, follow the steps in "Understanding the Configuration Menu" to display **ud**. Then, rotate **TUNE** to select either **UP** or **DN**.

USING THE POWER-SAVE FEATURE

To set the transceiver to save power press **F + SAVE** so that **SAVE** appears on the display. In the power-save mode, the transceiver turns on the receiver for about 32 milliseconds to check for any activity, and then turns off the receiver for the time you set with the power-save configuration setting. The factory default for this setting is to use only 1/16 the normal power. To change the power save setting, follow the steps in "Understanding the Configuration Menu" to display **PS**. Then, rotate **TUNE** to select the power save setting. You can set the power-save setting to **1-2**, **1-4**, **1-8**, or **1-16** (1/2, 1/4, 1/8, or 1/16 normal power usage).

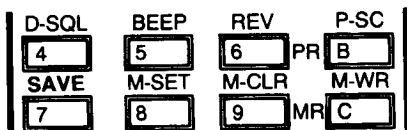
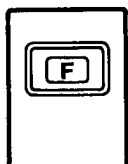

Press **F + SAVE** again to turn off power save. Power save temporarily turns off while scanning.

PREVENTING TRANSMISSIONS

To prevent any transmissions using the transceiver, turn on the transmit inhibit function. To turn on this function, follow the steps in "Understanding the Configuration Menu" to display **tE**. Then, rotate **TUNE** to select **ON**. To enable transmissions, set this option to **OFF**.

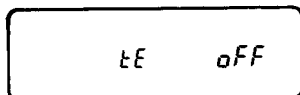

LIMITING TRANSMISSION DURATION

When you communicate on the 2-meter band, you should keep your transmissions as brief as possible. Most repeaters have built-in timers that limit single transmissions to 3 minutes or less. You can set the transceiver to stop transmitting and sound a beep if you exceed a set time limit with a single transmission. To set a transmit limit, follow the steps in "Understanding the Configuration Menu" to display **to**. Then, rotate **TUNE** to select **OFF**, **30**, **60**, or **120** seconds.

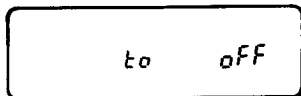

SETTING THE PRIORITY SCAN TIME

When you turn on priority scan, the transceiver checks the programmed priority-frequency memories periodically to see if there is any activity. As factory set, the transceiver checks the priority-frequency memories every 4 seconds. To change the priority scan time, follow the steps in "Understanding the Configuration Menu" to display **Lb**. Then, rotate **TUNE** to select **4**, **8**, **12**, or **16** seconds.

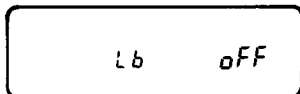

USING TOUCH-TONE FEATURES

Your transceiver has a built-in 16-key touch-tone encoder. You can manually send touch tones, or send the tones from one of five DTMF memories. You can also set your transceiver so that it is silent until it receives a specific sequence of touch tones.

Manually Sending Touch Tones

Some repeaters require you to enter a touch-tone code to key-up the repeater. Also, some repeaters have autopatch devices that let you make telephone calls through the repeater. To manually send the required tones, press and hold down **PTT**. Then, enter the touch-tone digits.

Notes:

- You must press **D** twice to send the **D** digit.
- If the auto-reply feature is turned off, you can release **PTT** after you enter the first digit. The transceiver continues to accept and transmit the touch-tone signals until you pause for at least 1 second.

Storing a DTMF Memory Sequence

You can store frequently-used touch-tone sequences in the transceiver's five DTMF memories. Each memory can hold up to 15 digits. Follow these steps to store touch-tone sequences.

1. Press and hold down **F + DTMF** for at least 1 second. The display changes to show the first DTMF memory.
2. Press **D**. Then, press a digit from 1-5 to select one of the DTMF memories.
3. Enter the touch-tone sequence. If the sequence is less than 15 digits, press **D**, then press a digit from 1 to 5 to select a different DTMF memory or press **PTT** to exit the DTMF memory store mode.

Note: To enter a **D**, press **D** twice.

Transmitting a DTMF Memory Sequence

To send a DTMF memory sequence, press and hold down **PTT**. Then, press **D** followed by the DTMF memory number you want to transmit (1-5). The transceiver transmits the tones.

The transceiver has two DTMF memory sequence transmit speeds. To switch between fast and slow, press and hold down **PTT**. Press **D**. Then, press **O**.

Note: If the auto-reply feature is turned off, you can release **PTT** after you press **D**. Enter the DTMF memory number within 1.5 seconds.

Using DTMF Squelch for Paging

The DTMF squelch feature lets you set your transceiver to release the squelch only if it receives a specific touch-tone sequence. Follow these steps to set the touch-tone sequence.

1. Press **F + D - SQL** for at least 1 second.

The transceiver displays the previous sequence or — if you have never programmed a sequence.

2. Enter the sequence (up to five digits).

3. Press **PTT** to save the sequence.

To turn on the DTMF squelch, press **F + D - SQL** for less than 1 second. **DTMF** appears in the display.

Your transceiver remains silent until it receives the correct touch-tone sequence. Then, it beeps and returns to normal operation. To cancel **DTMF** squelch, press **F + D - SQL** for less than 1 second so that **DTMF** disappears from the display.

Automatically Sending a DTMF Reply

You can set your transceiver to automatically transmit the touch-tone digit (#) when you have enabled **DTMF** squelch and the transceiver receives the correct touch-tone sequence. To turn on the **DTMF** auto-reply, follow the steps in "Understanding the Configuration Menu" to display **Ar**. Then, rotate **TUNE** to select **on**.

You should also set this option to **on** if you expect an auto reply from an autopatch or another HTX-202 or other transceiver that has this feature.

CARE AND MAINTENANCE

Your HTX-202 2-Meter Handheld Transceiver is an example of superior design and craftsmanship. The following suggestions will help you care for your transceiver so that you can enjoy it for years.



Keep the transceiver dry. If it does get wet, wipe it dry immediately. Liquids can contain minerals that corrode the electronic circuits.



Use and store the transceiver only in normal temperature environments. Temperature extremes can shorten the life of electronic devices and distort or melt plastic parts.



Handle the transceiver gently and carefully. Dropping it can damage circuit boards and cases and can cause the transceiver to work improperly.



Keep the transceiver away from dust and dirt, which can cause premature wear of parts.



Wipe the transceiver with a dampened cloth occasionally to keep it looking new. Do not use harsh chemicals, cleaning solvents, or strong detergents to clean the transceiver.

Modifying or tampering with your transceiver's internal components can cause a malfunction and might invalidate its warranty and void your FCC authorization to operate the transceiver. If your transceiver is not performing as it should, take it to your local Radio Shack store. Our personnel can assist you and arrange for service if needed.

ERROR CODES

Your transceiver has two error code displays. Refer to the following for an explanation of each error code.

Er1: Internal RAM Error

Er1 indicates the transceiver has detected an error in its battery-backed up option memory. This is most commonly caused by a low lithium backup battery, but can also be caused by static discharge, or a physical shock. To clear the error, reset the transceiver by turning it off, then holding down **F + D** while you turn it on again. This clears and reinitializes memory.

If the transceiver frequently displays the error, have the battery replaced by an authorized Radio Shack service center.

Er2: PLL Unlock Error

Er2 indicates the transceiver's PLL section has *unlocked*. Have the transceiver repaired by an authorized Radio Shack service center.

SPECIFICATIONS

GENERAL

Frequency Range	144.000-148.000 MHz
Frequency Step	5/10/15/20/25/50/100 KHz
Frequency Stability	+/- 10 ppm
Antenna Impedance	50 Ohms Unbalanced
Speaker	8 Ohms
Microphone	condenser Mic. 1.2 Kohms
Channel Display	LCD 8 digits
Operating Temperature	14°F to 140°F (-10°C to 60°C)
Size	2 ⁹ / ₁₆ × 4 ⁵ / ₈ × 1 ⁷ / ₈ Inches (65 × 117 × 37 mm)
Weight	1 lbs 3 ozs (540g)
Supply Voltage:	
Alkaline Battery Pack	9 VDC
Ni-Cad Battery Pack (600mAh)	7.2 VDC
External Power Jack	7.2 to 13.8 VDC

RECEIVER

Intermediate frequency

1st IF	21.4MHz
2nd IF	455KHz

Sensitivity:

12dB SINAD	0.2μV
20 dB NQ	0.35μV

(pd: Potential Difference)

Squelch sensitivity:

Threshold	0.1μV
Tight	10dB above threshold

Spurious response attenuation

Intermodulation attenuation

Adjacent channel rejection (25KHz)

Modulation acceptance Bandwith

Hum and Noise

Audio output power (10% THD):

7.2V DC

9V DC

12V DC

13.8V DC

Audio distortion

Audio response

Current drain:	
Stand-by without power save	35mA
Stand-by power save	25mA
CTCSS Sensitivity	0.15 μ V
DTMF Squelch sensitivity	0.2 μ V

TRANSMITTER

RF Power output:	
7.2V DC	2.5W
9V DC	4W
12V DC	5W
13.8V DC	6W
Low Power	1W
Maximum deviation	4.5KHz
Hum and Noise	42dB
Audio distortion	0.5%
Audio response	+ 6dB/oct
Spurious and harmonic emissions	70dB
Frequency error	\pm 0.0005%
Mic. Sensitivity	4mVrms
CTCSS Tone deviation	0.7KHz
DTMF Tone deviation	3.5KHz
Current drain:	
7.2V DC	0.8A
9V DC	0.95A
12VDC	1A
13.8VDC	1.1A
Lower Power	0.46A

The above specifications are nominal. An individual unit's performance might vary slightly from these specifications.

SCHEMATIC DIAGRAM

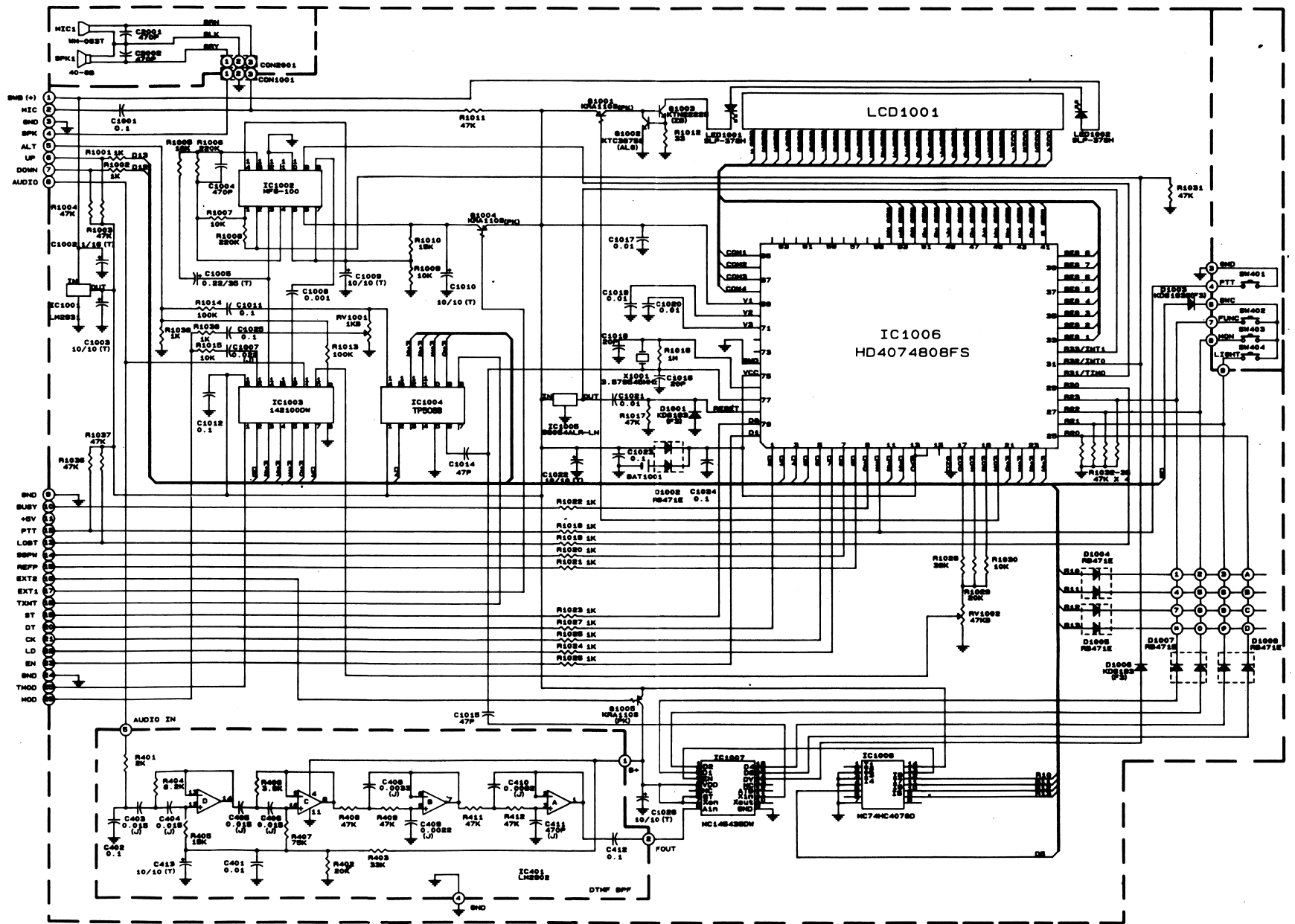

SCHEMATIC DIAGRAM

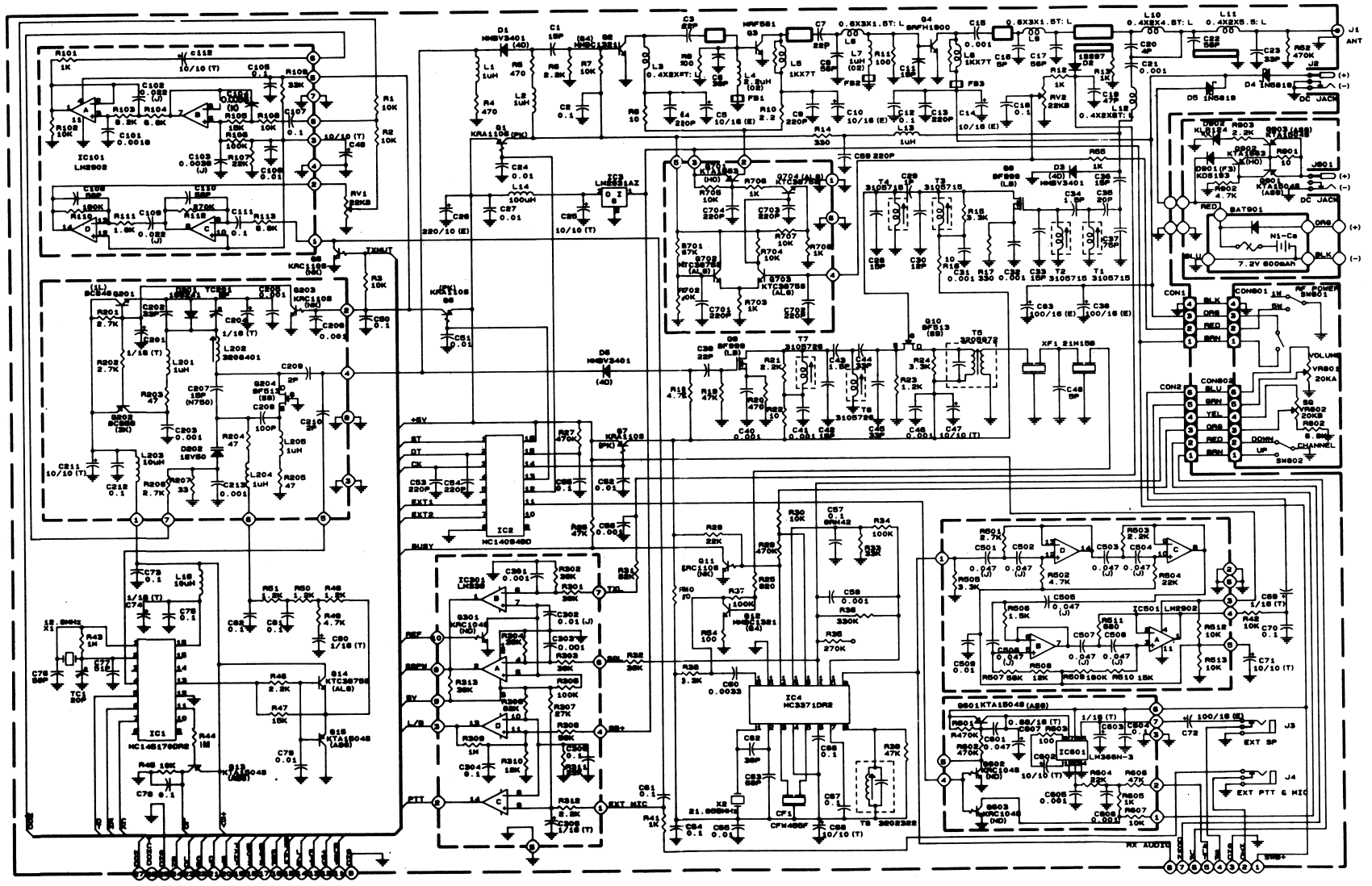

KEY INDEX

- CA** **LOCK**
A **PTT+A** - Transmit DTMF A. Page 33.
F+LOCK - Keyboard lock. Page 19.
CA - Calling Memory. Page 20.
- PR** **P-SC**
B **PTT+B** - Transmit DTMF B. Page 33.
F+P-SC - Priority scan. Page 22.
PR - Priority Memories. Page 22.
- MR** **M-WR**
C **PTT+C** - Transmitt DTMF C. Page 33.
F+M-WR - Memory write. Pages 20-23.
MR - Standard Memories. Page 23.
- VF** **M→VFO**
D **PTT+D** - Transmit DTMF D. Follow with 1-5 to send a DTMF sequence. Pages 33 and 34.
F+M→VFO - Write memory to VFO. Page 24.
CLR **VF** - VFO mode. Page 16.
CLR - Clear partially entered frequency in VFO mode. Page 16.
- T-SQL**
1 **PTT+1** - Transmit DTMF 1. Page 33.
F+T-SQL - Tone-squelch. Page 28.
1 - In Standard Memory mode, 1st digit of selecting memory 10, 11, or 12, Page 23. In VFO mode, enter a frequency. Page 16. In Priority Memory mode, select Priority Memory 1. Page 22.
- D-SQL**
4 **PTT+4** - Transmit DTMF 4. Page 33.
F+D-SQL - DTMF-squelch. Page 34.
4 - In Standard Memory mode, select Memory 4. Page 23. In VFO mode, enter a frequency. See Page 16.
- SAVE**
7 **PTT+7** - Transmit DTMF 7. Page 33.
F+SAVE - Power-save option. Page 31.
7 - In Standard Memory mode, select Memory 4. Page 23. In VFO mode, enter a frequency. Page 16.
- *
▼SC** **PTT+*** - Transmit DTMF *. Page 33.
F+▼SC - In VFO mode, scan down in the selected range. Page 30.
▼SC - In VFO, Priority-Memory, or Standard-Memory mode, scan down. Pages 17, 22, and 23. In memory-set mode, next menu item. Page 26.

DTMF

2

PTT + 2 - Transmit DTMF 2. Page 33.

F + DTMF - Store DTMF memory sequence Page 33.

2 - In Standard Memory mode, select Memory 2. Page 23. In VFO mode, part enter frequency. Page 16. In Priority Memory mode, select Priority Memory 2. Page 22.

BEEP

5

PTT + 5 - Transmit DTMF 5. Page 33.

F + BEEP - Key entry beep. Page 19.

5 - In Standard Memory mode, select Memory 5. Page 23. In VFO mode, enter a frequency. Page 16.

M-SET

8

PTT + 8 - Transmit DTMF 8. Page 33.

F + M - SET - In VFO mode, memory set. Page 26. In Standard Memory, Priority memory, and Calling-Frequency memory mode, change options for memory channel. Page 21.

8 - In Standard Memory mode, select Memory 8. Page 19. In VFO mode, enter a frequency. Page 18.

V-SC

0

PTT + 0 - Transmit DTMF 0. Page 33.

F + V - SC - Vacant scan. Page 18.

0 - In Standard Memory mode. 1st digit to select Memory 01. Page 23. In VFO mode, enter a frequency. Page 16.

+/-

3

PTT + 3 - Transmit DTMF 3. Page 33.

F + +/- - Duplex offset. Page 18.

3 - In Standard Memory mode, select Memory 3. Page 26. In VFO mode, enter a frequency. Page 16. In Priority Memory mode, select Priority Memory 3. Page 22.

REV

6

PTT + 6 - Transmit DTMF 6. Page 33.

F + REV - Reverse transmit and receive frequencies. Page 19.

6 - In Standard Memory mode, select Memory 6. Page 26. In VFO mode, enter a frequency. Page 16.

M-CLR

9

PTT + 9 - Transmit DTMF 9. Page 33.

F + M - CLR - Memory clear. Page 24.

9 - In Standard Memory mode, select Memory 9. Page 26. In VFO mode, enter a frequency. Page 16.



PTT-# - Transmit DTMF #. Page 33.

F+▲SC- In VFO mode, scan up selected range. Page 30.

▲SC - In VFO, Priority-Memory, or Standard-Memory mode, scan up. Pages 17, 22, and 23. In memory-set mode, previous menu item. Page 26.

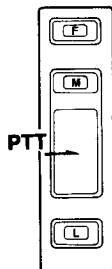

F - Select the 2nd function of a key.

M - Monitor a channel without squelch. In Standard, Priority, or calling Memory mode, display memory's programmed options. Page 25.

PTT - Push-to-talk (transmit button)

L - Turn on the light for 5 seconds. Page 15.

F+L - Turn on the light until you press L again to turn it off. Page 15.

RADIO SHACK LIMITED WARRANTY

This product is warranted against defects for 1 year from date of purchase from Radio Shack company-owned stores and authorized Radio Shack franchisees and dealers. Within this period, we will repair it without charge for parts and labor. Simply **bring your Radio Shack sales slip** as proof of purchase date to any Radio Shack store. Warranty does not cover transportation costs. Nor does it cover a product subjected to misuse or accidental damage.

EXCEPT AS PROVIDED HEREIN, RADIO SHACK MAKES NO EXPRESS WARRANTIES AND ANY IMPLIED WARRANTIES ARE LIMITED IN DURATION TO THE DURATION OF THE WRITTEN LIMITED WARRANTIES CONTAINED HEREIN. Some states do not permit limitation or exclusion of implied warranties; therefore, the aforesaid limitation(s) or exclusion(s) may not apply to the purchaser.

This warranty gives you specific legal rights and you may also have other rights which vary from state to state.

We Service What We Sell

9/94

RADIO SHACK
A Division of Tandy Corporation
Fort Worth, Texas 76102